

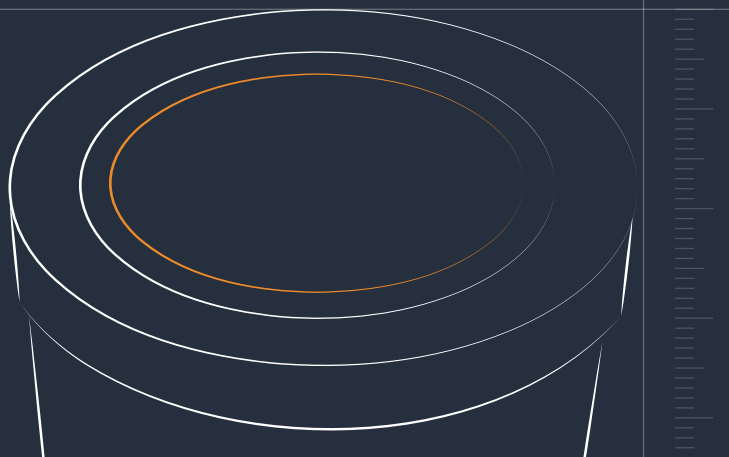

# High-quality and precise finishing of single components

Drag finisher  
Surf-finisher  
Plunge finisher

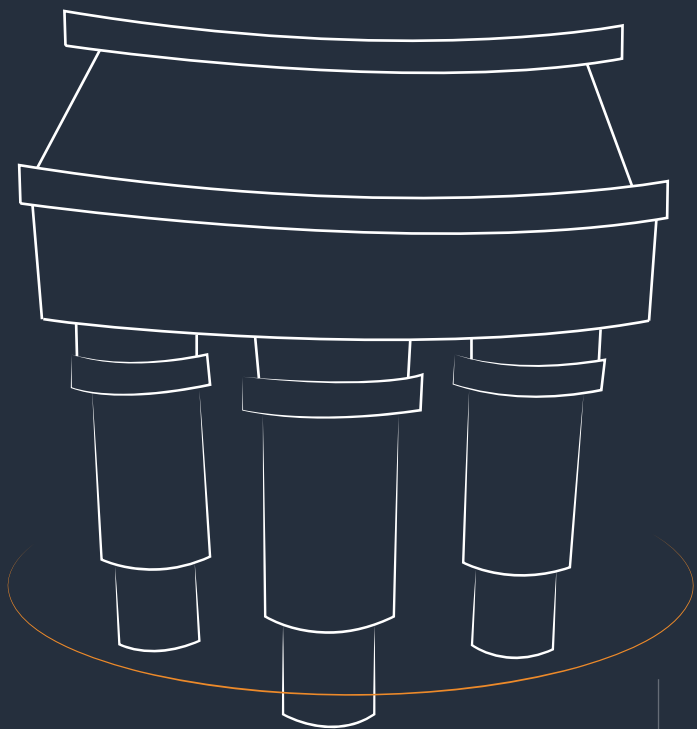

## Mass Finishing



High-performance equipment and innovative technologies – productive and cost-effective

## Shot Blasting

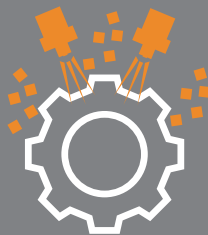

Customer-oriented equipment technology and intelligent process solutions – long-lasting and energy-efficient

## AM Solutions



Comprehensive solutions for additive manufacturing, especially 3D post processing equipment

› **80**

More than 80 years of **experience**



**15** locations –  
over **150** distributors –  
over **1,500** employees **across the globe**



Worldwide **Customer Experience Center**



More than **15,000**  
**different types of media and compounds**

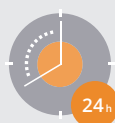

Our technical service –  
**round-the-clock support**



**Transfer of professional knowledge**  
by certified trainers

## Contents

Drag finishing	
Functional principle	4 - 5
Design Features	6 - 7
Drag finishers, model range SF	8
Drag finishers, model range SF-A (automation)	9
Large drag finishers and special finishing solutions	10
Surf-finishing	
Functional principle	11
Design features	12 - 13
Surf-finisher with robot-guided work piece finishing	14
Multi Surf-Finisher	15
Plunge finishing	
Functional principle	16
Plunge finishing equipment	17
Custom-engineered automated finishing solutions	18 - 19
Digitization Industry 4.0 - Rösler Smart Solutions	20
Media and compounds	21
Customer experience center mass finishing	22
Rösler Academy	23

## DRAG FINISHING EQUIPMENT

Rösler drag finishing machines represent the ideal finishing solution for **high-value, delicate and geometrically intricate work pieces**, which must not touch each other during the entire finishing process. Compared to traditional mass finishing methods, drag finishers achieve a **40 times higher processing**

**intensity**. Because it produces absolutely repeatable results, allows the integration of different finishing steps into one single process and requires very short cycle times, the drag finishing technology is the ideal solution for automated finishing processes.

### Functional principle

Drag finishers consist of a carousel equipped with up to 12 rotating work stations and a stationary work bowl filled with grinding or polishing media. For certain applications each work station can be equipped with multiple rotating spindles. The work pieces are attached to the rotating work stations or spindles with special work piece holders. As the carousel is lowered, the work pieces are immersed into the processing media. The carousel rotation along with the rotation of the work stations and spindles causes the work pieces to collide with the stationary processing media causing a high amount of pressure between media and work pieces. This guarantees absolutely homogeneous finishing results. The immersion depth and rotational speed of carousel, work stations and spindles can be individually adjusted. A simple exchange of work bowls containing different media allows wet and dry processing as well as combinations of different finishing processes.



### Applications

Drag finishing is ideal for processing high-value, geometrically intricate and delicate work pieces requiring a precise and targeted surface finish. Throughout the entire process the work pieces never touch each other. An extremely sturdy equipment design allows the treatment of work pieces with dimensions of up to 700 mm and weights of up to 300 kg. Drag finishers are frequently used for applications in the medical engineering, aerospace and tooling industry. However, they are also utilized for finishing drive train and transmission components. Drag finishing is equally effective for deburring, edge radiusing, surface grinding, smoothing and polishing.



**RÖSLER**  
finding a better way ...

consistent

powerful

reliable

precise

RÖSLER



# DESIGN FEATURES

Rösler drag finishers are characterized by their **exceptionally high productivity** and a **surprisingly small foot-print**. This allows the integration of the most complex grinding and polishing operations into any manufacturing line.

1

## Overall design

- ▶ Sturdy and noise-absorbing enclosure
- ▶ Access door with a sash (sliding) window for easy and ergonomic work piece loading/unloading
- ▶ Plug & Play design minimizes the time for installation and commissioning

2

## Drive unit

- ▶ Carousel, work stations and spindles equipped with separate drive systems; allows the optimal adaptation of the processing intensity to the required finishing results
- ▶ Monitoring of the immersion depth helps to prevent work piece and machine damage
- ▶ Two-hand positioning of the carousel for easy work piece loading and unloading

3

## Spindles

- ▶ Flexible amount of rotating spindles on the work stations. 2, 3, 4, 6 spindles possible. Equipped with quick-connect couplings for the work piece holders
- ▶ Work stations or spindles can be tilted at an angle of up to 25°
- ▶ Different spindle head versions available: Mono- or multi-spindle heads guarantee the best possible finishing results



Mono-spindle head



Multi-spindle head

4

## Work piece holders

- ▶ For attaching the work pieces to the work stations
- ▶ Manual or automated attachment of the work pieces to the work stations/spindles
- ▶ Depending on the work piece shape and finishing process, individualized handling solutions are available, all made in-house
- ▶ The work piece holders are precisely adapted to the respective machine type

5

## Work bowl

- ▶ Highly robust polyurethane wear lining
- ▶ Wet and dry processing possible
- ▶ Work bowl exchange requires no tools
- ▶ Adjustment of the water level in the work bowl allows the precise adaptation of the processing intensity and, thus, ensures perfect finishing results
- ▶ Automatic replenishment of the processing media guarantees absolutely consistent surface finishes

6

## Repeatable finishing processes

Wet processing:

- ▶ Vibratory motor in the bottom of the work bowl for intensive mixing of the processing media
- ▶ Large screens for undersized media discharge and powerful rinsing

Dry processing:

- ▶ Dust collector
- ▶ Cooling unit
- ▶ Sensor controlled media replenishment

7

## Controls

- ▶ Electrical controls equipped with PLC and user-friendly operator panel (HMI)
- ▶ Allows operation with different processing programs
- ▶ Easy integration into the customer ERP / MES systems
- ▶ Remote trouble shooting
- ▶ Optional tracking system for collection of the work piece data

8

## Dosing system for flow-through or recycling mode for the process water

- ▶ Integrated work piece cleaning station
- ▶ Individual adaptation of the process water flow to each processing stage

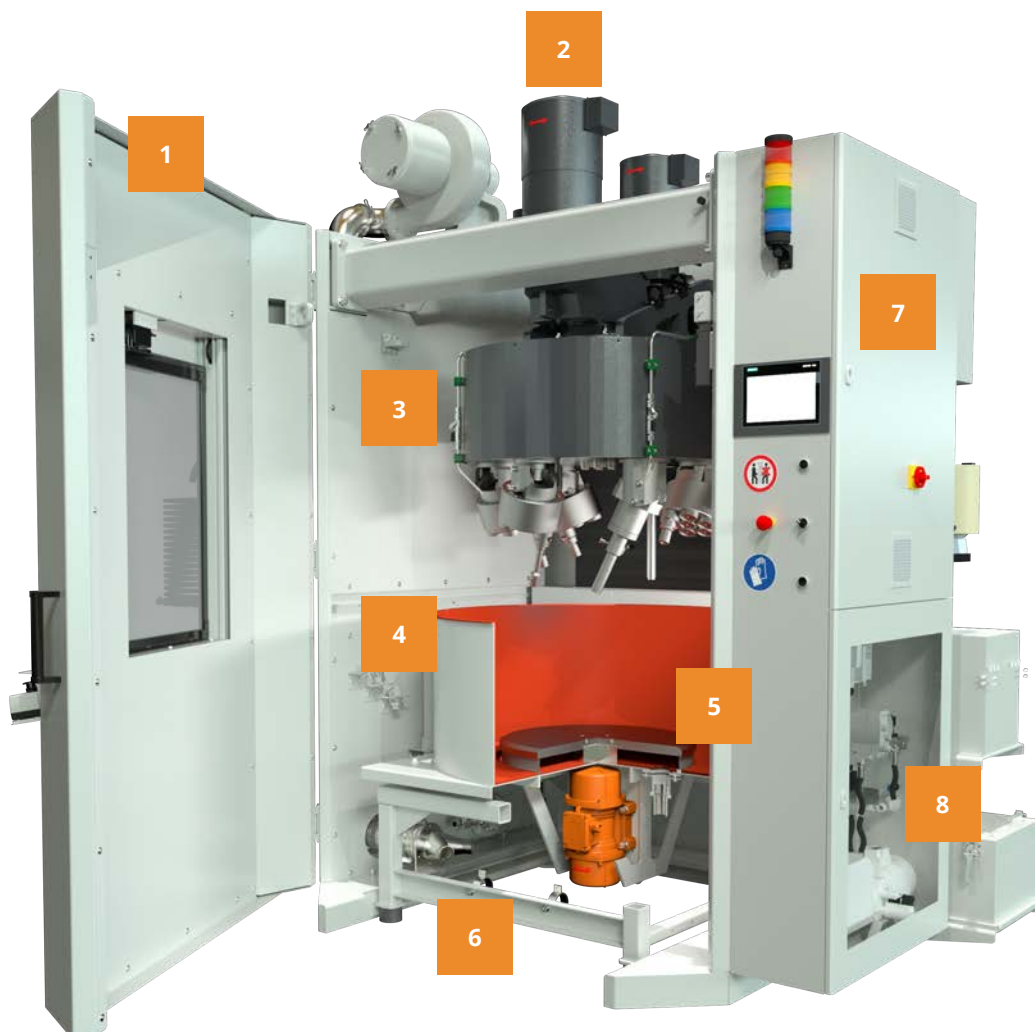

## DRAG FINISHERS, MODEL RANGE SF

For manual mounting of the work pieces to the work stations/spindles

SF drag finishers are ideal for finishing work pieces that are produced in **small and midsize volumes**. The raw work pieces are **manually mounted** to the work stations/spindles. Mounting and dismounting can be **easily handled** through

an access door equipped with a sash (sliding) window. Various programs, easily called up through the HMI, allow running different finishing processes with precisely defined operational parameters.

### Technical highlights

- ▶ Torsionally rigid equipment design
- ▶ Separate drive units for the carousel and the work stations
- ▶ Angle adjustment for the work stations and spindles
- ▶ Manual mounting of the work pieces to the work stations
- ▶ Two-hand positioning of the carousel for easy work piece loading and unloading
- ▶ Adjustable immersion depth for the work stations with attached work pieces

### Options

- ▶ Specially designed work piece holders
- ▶ Cooling system
- ▶ Noise protection
- ▶ Automatic media replenishment
- ▶ Special suction device for extracting the media from the work bowl



Rösler  
drag finisher, model R 2/700 SF

### Technical data

Model range:	R 4/700 SF	R 4/700 SF.2	R 6/1000 SF
Number of work stations	4	4	6
Number of work bowls	1	2	1
Work bowl diameter (mm)	700	700	1,080
Installed electrical load (kW)	9	9	12.5
Overall dimensions (L x W x H) (m)	2.1 x 1.5 x 2.6	3.4 x 1.5 x 2.6	2.3 x 1.9 x 2.8

Additional specifications available upon request



# DRAG FINISHERS, MODEL RANGE SF-A

For fully automatic processing

Drag finishers of the model range SF-A can be **fully automated including the utilization of suitable robots**. The automation not only includes the automatic loading/unloading of the work pieces but also the entire process sequence as well as

the cleaning of the finished work pieces. With sophisticated **automation solutions, all designed in-house**, we will gladly develop a concept tailored to your specific finishing requirements.

## Technical highlights

- ▶ Torsionally rigid equipment design
- ▶ Servo drive technology allows precise positioning of the carousel and the work stations for loading/unloading of the work pieces
- ▶ Angle adjustment for the work stations and spindles
- ▶ Automatic clamping of the work pieces, respectively, work piece holders
- ▶ Expanded system controls for integrating peripheral equipment
- ▶ Adjustable immersion depth for the work stations with attached work pieces
- ▶ Separate windows in the machine enclosure for loading and unloading of the work pieces

## Options

- ▶ Specially designed work piece holders
- ▶ Special work piece clamping and release solutions
- ▶ Work piece cleaning station
- ▶ Cooling system
- ▶ Noise protection
- ▶ Automatic media replenishment
- ▶ Special suction device for extracting the media from the work bowl



Rösler  
drag finisher R 4/800 SF-A

## Technical data

Model range:	R 2/800 SF-A	R 3/800 SF-A	R 4/800 SF-A	R 4/1000 SF-A	R 6/1000 SF-A
Number of work stations	2	3	4	4	6
Number of work bowls	1	1	1	1	1
Work bowl diameter (mm)	800	800	800	1,080	1,080
Installed electrical load (kW)	9	11	13	13	14
Overall dimensions (L x W x H) (m)	2.1 x 1.9 x 3.4	2.1 x 1.9 x 3.4	2.1 x 1.9 x 3.4	2.3 x 2.4 x 3.5	2.3 x 2.4 x 3.5

Additional specifications available upon request

# LARGE DRAG FINISHERS AND SPECIAL FINISHING SOLUTIONS

For processing of large and heavy work pieces

Large drag finishers are **especially sturdy** machines for finishing **large and heavy work pieces**. Equipped with multiple

multi-purpose work stations, they allow the processing of large work piece volumes.



Rösler  
drag finisher R 4/1300.2 SF

## Technical data

Model range:	R 4/1300 SF	R 4/1300.2 SF
Number of work stations	4	4
Number of work bowls	1	2
Work bowl diameter (mm)	1,280	1,280
Installed electrical load (kW)	23	23
Overall dimensions (L x B x H) (m)	2.5 x 3.2 x 2.5	6.5 x 3.5 x 2.5

Additional data available upon request

## Special solutions

Are you not finding a suitable solution in our range of standard machinery? We also offer custom-engineered drag finishers that are tailored to the individual customer needs.

We will gladly develop an equipment concept and finishing process that meets your specific technical requirements.

# SURF-FINISHING

Surf-finishing is the **most intensive** mass finishing technology. It is particularly suited for **high-value components with complex shapes** that can be **easily clamped**. Compared to conventional vibratory finishing this technology increases the **processing intensity by a factor of 50!** Rösler surf-finishers **replace** time-consuming, costly manual finishing operations.

Because of their high process stability they represent a real alternative to brush deburring, belt grinding and dedicated polishing equipment. Depending on the specific technical requirements, the desired finishing results can be achieved in cycle times of 30 seconds to 10 minutes.

## Functional principle

Rösler offers two equipment types: (1) Surf-finishers with robot-guided work piece finishing in the work bowl and (2) Multi-surf-finishers with multiple work spindles attached to a carousel. The rotation of the work bowl, filled with processing media, results in an extremely intensive finishing operation with short cycle times. The robot-guided finishing process can precisely expose the different work piece contours to the media in the rotating work bowl. In the multi-surf-finisher the work pieces are attached to the work spindles and finished through a simultaneous tilting and rotational motion. Surf-finishing allows the targeted finishing of precisely defined surface sections on the work pieces. Robot-guided as well as multi-surf-finishers allow the simultaneous processing of several work pieces. They are equally suitable for wet and dry finishing operations.



## Applications

The surf-finishing technology opens entirely new fields for mass finishing, especially for high-value precision components requiring the targeted finishing of specific surface areas. Even on work pieces with complex shapes it produces perfect surface finishes with roughness readings of  $Ra < 0,02 \mu\text{m}$ , or  $Rz < 0,2 \mu\text{m}$ . An important precondition is that their shape must allow easy clamping of the work pieces.

The surf-finishing technology is particularly suitable for applications in the medical device, aerospace and tooling industry. However, it also offers numerous benefits for finishing drive train and transmission components. Surf-finishing is equally effective for the precisely defined deburring, edge radiusing, surface grinding, smoothing and, even, high-gloss polishing.



## DESIGN FEATURES

---

The Rösler surf-finishers offer **top performance** and **excellent precision**. In combination with **automated work piece handling** the surf-finishing technology is **equally effective** in treating only **targeted** or **all surface areas** on the work pieces. With numerous concepts we can offer individualized automation solution for our customers.

1

### Work piece logistics

- ▶ The work piece handling, including transport, is adapted to the individual customer requirements. Generally, this is fully automated.

2

### Work bowl

- ▶ Work bowl is rotating
- ▶ Different work bowl sizes
- ▶ Variable rotational speed
- ▶ Optimal supply and discharge of the process water

3

### Robot-guided surf-finishing system

- ▶ 6-axis industrial robot
- ▶ The work pieces, precisely placed in a staging area, are picked up by the robot(s) equipped with special grippers
- ▶ Internal or external gripping or preparatory mounting of the work pieces to suitable work piece holders

4

### Equipment controls

- ▶ Control panel with PLC and large operating panel (HMI) (operating panel can be detached)
- ▶ Allows operation with different processing programs
- ▶ Easy integration into the customer ERP / MES systems
- ▶ Remote trouble shooting
- ▶ Optional tracking system for collection of the work piece data

5

### Process water dosing system

- ▶ Individual adaptation of the process water flow to each processing stage

6

### Work piece cleaning station

- ▶ For the removal of residual media, metal & media fines and general contaminants
- ▶ Cleaning by compressed air or process water



# SURF-FINISHER

With robot-guided work piece finishing

Surf-finishers are **extremely flexible** and **high-performance** finishing systems **for treating single high-value components**. Depending on the work piece size and weight we can offer different machine sizes. Robotic work piece handling allows

**fully automatic operation** with a practically unlimited amount of motions in the work bowl. This results in **individualized** surface finishing processes with absolutely **repeatable results**.

## Technical highlights

- ▶ Robot-guided work piece finishing
- ▶ Individualized gripper solutions
- ▶ Rotating work bowl
- ▶ 6-axis industrial robot
- ▶ Protective enclosure
- ▶ Expanded system controls for integrating peripheral equipment

## Options

- ▶ Work piece cleaning station
- ▶ Individualized work piece logistics
- ▶ Expansion by one additional industrial robot
- ▶ Noise protection
- ▶ Automatic media replenishment
- ▶ Special suction device for extracting the media from the work bowl



Rösler surf-finisher 700



Scan or click to see the Surf-Finisher in action

## Technical data

Model range:	RSF 700	RSF 1800
Work bowl diameter (mm)	850	1.780
Installed electrical load (kW)	12	23
Overall dimensions (L x B x H) (m)	2,9 x 2,0 x 2,4	4 x 3,2 x 2,6

Additional specifications available upon request

# MULTI-SURF-FINISHER

For fully automated and intensive finishing operations

The multi-surf-finisher allows the simultaneous processing of **multiple work pieces**. Like in drag finishing systems the work pieces, mounted to special work piece holders, are clamped to the work spindles. The main difference is that the work spindles, as well as the work bowl filled with grinding or polishing

media, are rotating. This results in a **much higher processing intensity**. The clamping of the work pieces to the spindles can be done manually (M model range), or it can be automated by using an industrial robot (A model range).

## Technical highlights

- ▶ Rotating work bowl with direct drive
- ▶ Torsion-resistant equipment design
- ▶ Servo drive technology allows precise positioning of the carousel and the spindles for loading/unloading of the work pieces
- ▶ Angle adjustment for the work spindles
- ▶ Variable number of working spindles
- ▶ Expanded system controls for integrating peripheral equipment
- ▶ Separate windows in the machine enclosure for loading and unloading of the work pieces

## Options

- ▶ Specially designed work piece holders
- ▶ Cooling system
- ▶ Noise protection
- ▶ Automatic media replenishment
- ▶ Special suction device for extracting the media from the work bowl



Rösler  
multi-surf-finisher RMSF 4/800-A

## Technical data

Model range:	RMSF 4/700-M	RMSF 4/800-A	RMSF 6/1000-A
Number of work spindles	4	4	6
Number of work bowls	1	1	1
Work bowl diameter (mm)	850	850	1,080
Automatic work piece loading	No	Yes	Yes
Installed electrical load (kW)	27	27	27
Overall dimensions (L x B x H) (m)	2.0 x 1.3 x 2.4	2.1 x 2.0 x 3.1	2.3 x 2.4 x 3.5

Additional specifications available upon request

## PLUNGE FINISHING

Rösler plunge finishers are particularly suitable for finishing **geometrically complex heavy** and **delicate work pieces**. The simultaneous rotational and up/down movements produce absolutely repeatable finishing results. By way of a special

clamping device the work pieces are mounted to the rotating work spindle and are immersed in the work bowl filled with processing media.

### Functional principle

The rotating work spindle immerses one work piece at a time into the work bowl filled with grinding or polishing media. The work spindle can actually execute different motions: Purely rotational, orbital and reciprocal (left/right). These motions, or a combination thereof, produce optimal finishing results. A vibratory motor mounted to the work bowl ensures a homogeneous mixing of the processing media. It also promotes the discharge of undersized media and facilitates the immersion of the work piece into the mix of processing media.



### Applications

Plunge finishers were designed for deburring, edge radiusing, surface grinding and polishing of large and heavy components. They are primarily used in the automotive and aerospace industry, but also for special industrial finishing applications.





# PLUNGE FINISHER

Specially designed machine for finishing large components

Plunge finishers are ideal for the surface finishing of **large and heavy work pieces** with a maximum length of 800 mm and weighing up to 200 kg. **Only one single work piece** is processed at a time. These are true mass finishing machines,

suitable for deburring, surface grinding and polishing. During the process the working spindle can perform different motions. This ensures optimal finishing results.

## Technical highlights

- ▶ Depending on the type of motion it needs to perform, the drive system for the main spindle can be a gear or a servo motor
- ▶ Manual or automatic clamping of the work piece to the working spindle
- ▶ Expanded system controls for integrating peripheral equipment
- ▶ Up-down spindle movement for treating internal surface areas
- ▶ Work bowl equipped with a vibratory motor to thoroughly mix the processing media in the work bowl
- ▶ Adjustable immersion depth

## Options

- ▶ Custom-engineered gripper solutions
- ▶ Noise protection
- ▶ Automatic media replenishment
- ▶ Special suction device for extracting the media from the work bowl



Scan or click to see the Plunge Finisher in action



Rösler  
plunge finisher R 1/1 TSA-O/VS

## Technical data

Model range:	R 1/1 TSA-O/VS	R 1/1 TSA-Z/IS	R 1/1 TSA-O
Possible motions	orbital / up/down variable spindle	circular / up/down inner spindle/paddle	orbital / up/down variable spindle
Spindle drives	Separate drive systems for the primary and secondary spindles	Separate drive system for the inner spindle/paddle	common drive system for the primary and secondary spindles
Work bowl diameter (mm)	1,170	1,050	1,050
Max. usable work bowl height (mm)	680	680	650
Installed electrical load (kW)	20	16	16

Additional specifications available upon request

# CUSTOM-ENGINEERED AUTOMATED FINISHING SOLUTIONS

The integration of mass finishing systems into fully automated manufacturing lines is major strength of the Rösler company. 9 out of 10 mass finishing systems leaving our manufacturing plants are custom-engineered solutions. Depending on the finishing task and the requested degree

of automation, we can provide a variety of material handling systems in combination with specially developed finishing processes. Rösler offers flexible modular systems, all made in-house, which meet any automation requirement the customers may ask for.

## The Rösler possibilities

- ▶ Work piece transfer modules to link the mass finishing system with upstream operations
- ▶ Work piece handling and transport
- ▶ Robotic handling systems
- ▶ Integration into work piece washing and drying systems
- ▶ Single piece quality control
- ▶ Packaging and staging of the work pieces for downstream operations
- ▶ Process water cleaning and recycling

## Additional Rösler services

- ▶ Work space studies including simulations of equipment layouts
- ▶ Cycle time studies to maximize productive and minimize idle times
- ▶ Virtual reality software for the presentation of equipment concepts

## Success stories



Two Rösler drag finishers R 6/1000 SF-A with robotic work piece handling



Rösler multi-surf-finisher RMSF 4/800-A with fully automated gantry loading system



Rösler multi-surf-finisher RMSF 4/800-A integrated into a fully automated processing line. Includes work piece handling with two industrial robots, Rösler continuous flow washing machine and final quality control with marking of the finished work pieces.

Scan or click to see the Multi-Surf-Finisher in action



# RÖSLER SMART SOLUTIONS

A digital added value to meet your challenges

Now is the time to promote the **digital transformation** and develop innovative digitization solutions. Under our new brand **Rösler Smart Solutions** we have developed a comprehensive digitization product that will allow you to **make processes**

**and their parameters more transparent** and to define the potential for substantial cost savings. Our package creates the **potential for optimization significant reduction of the operating costs.**

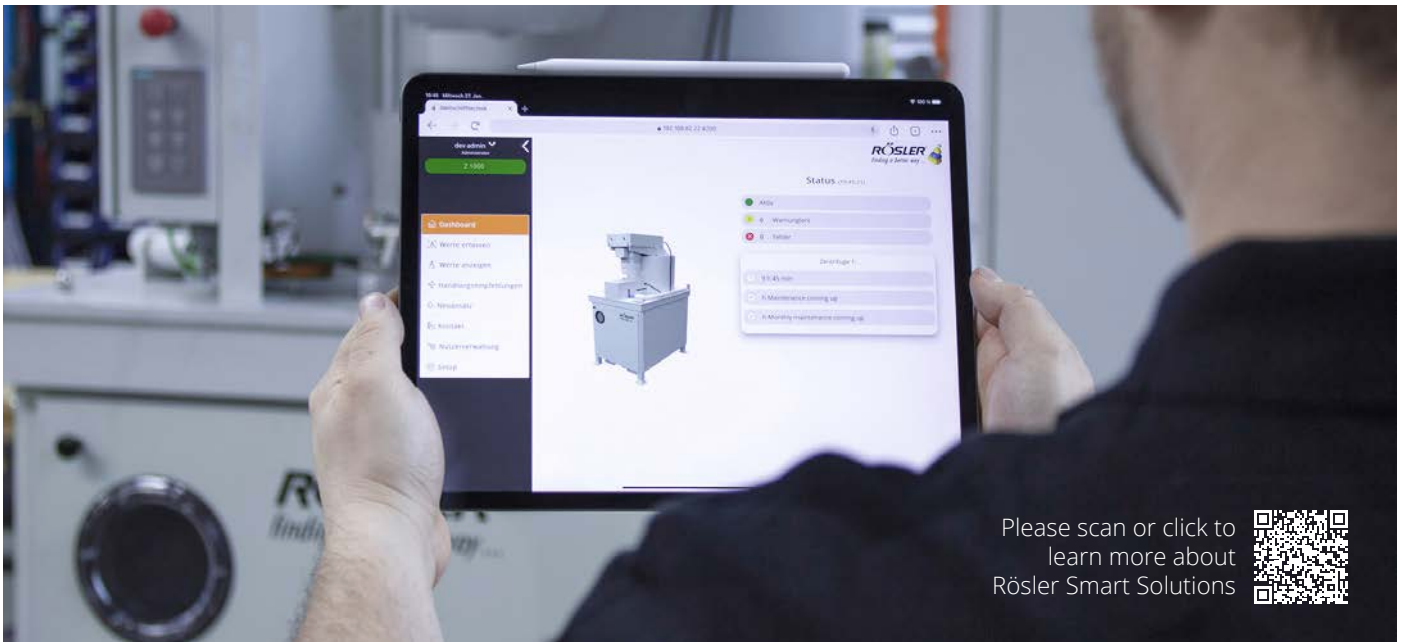

Please scan or click to learn more about Rösler Smart Solutions



Transparency of processes and costs.



Process monitoring and recording of data.



Quick correction of deviations and faults.



Intelligent operation with uptime projections.



Optimized utilization of resources and cost reduction.

# MEDIA AND COMPOUNDS

In addition to our machine program, we also offer the most comprehensive range of media and compounds in the world. All our consumable products have been developed and produced in-house with „Made in Germany“ quality. With over 80 years of

experience in the field of surface finishing we can provide our customers with tailormade processes for new applications and solutions for product improvement and cost reductions.

**Stable and repeatable finishing processes are our specialty.**



### The world's largest range of media and compounds

With around 15,000 products our portfolio of consumables is the largest in the world. It includes ceramic and plastic grinding and polishing media, compounds and process water cleaners. All our consumables can be individually adapted to the needs and requests of our customers.



Our ceramic media production

### Quality

Our production complies with the most stringent environmental standards and is subject to strict quality controls per DIN EN ISO 9001 and 50001.

### Excellent product availability

Our central warehouse in Germany stocks more than 8,000 tons of media and compounds. In addition, our global network of branches and many of our channel partners maintain warehouses with consumables close to our customers.

# CUSTOMER EXPERIENCE CENTER

## MASS FINISHING

A major strength of the Rösler business approach is that **we look at all aspects of a finishing task**. The equipment and the processes are individually tailored to the respective finishing requirements, but also to their optimal integration into the customer's manufacturing operation. Most of the Rösler sales

branches have their own **Customer Experience Centers (CEC)**, equipped with the latest finishing equipment.

To investigate the various finishing possibilities, in our CEC we are conducting **processing trials** with the work pieces of our respective customers.



### Process development and process optimization

**Our all-around approach** guarantees perfect finishing solutions. This includes processing trials, process development, selection of the right machinery and a professional after sales service.

In our CEC, equipped with ultra-modern equipment, we can run practically any mass finishing process.

State-of-the-art **physical and chemical measuring** equipment represents a vital tool for process development and optimization.

The entire focus of our specialists in the engineering and R & D departments is on developing **tailormade finishing solutions**.

### Product development and optimization

The enormous depth of the Rösler product range, CEC around the world and our well-equipped laboratory at the Untermerzbach location in Germany are an excellent basis for the development of innovative and cost-efficient products in the field of mass finishing.

All our products, be it consumables, finishing equipment,

vibratory motors, process water cleaning centrifuges, as well as work piece handling systems and post processing equipment like dryers, are **developed and manufactured** in-house. Such a high manufacturing depth is unparalleled in our industry.

# LEARNING FROM THE GLOBAL LEADER

Our comprehensive mass finishing knowhow is founded on over 80 years of experience. As the global technology and market leader in the field of surface treatment we can offer proven

solutions ranging from a broad equipment and consumables portfolio to round-the-clock after-sales service. In our training seminars we are passing our extensive knowledge on to you.



## Rösler Academy

The central training center of the Rösler Oberflächentechnik GmbH

- ▶ An area of more than 1,350 m<sup>2</sup> for learning and working
- ▶ Equipped with the latest digital media and communication technologies
- ▶ Certified professional trainers
- ▶ Specialized fields: Mass finishing, shot blasting, lean management
- ▶ More than 10 different training seminars
- ▶ Focus on hands-on learning
- ▶ Training seminars in German and English
- ▶ Customized training seminars at customer locations upon request

## Our professional trainers

All our trainers are certified and are among the best in their respective fields. In our training seminars you will benefit from the extensive experience of our trainers, who will provide you with first-hand practical knowledge.

Ø Participants per year



Over 1,000

Ø Rating



9.6 out of 10 possible points<sup>1</sup>

Ø Recommendation rate



99 %<sup>1</sup>

<sup>1</sup> Source: Evaluation questionnaires filled out by participants, Status 31/12/2022

You can find more information about our seminars, dates and registration procedures under [www.rosler-academy.com](http://www.rosler-academy.com) or scan the QR-Code.



Mass Finishing  
Shot Blasting  
AM Solutions  
[www.rosler.com](http://www.rosler.com)

#### Germany

**Rösler Oberflächentechnik GmbH**  
Werk Memmelsdorf  
Vorstadt 1  
D-96190 Untermmerzbach  
Tel.: +49 9533 / 924-0  
Fax: +49 9533 / 924-300  
[info@rosler.com](mailto:info@rosler.com)

**Rösler Oberflächentechnik GmbH**  
Werk Hausen  
Hausen 1  
D-96231 Bad Staffelstein  
Tel.: +49 9533 / 924-0  
Fax: +49 9533 / 924-300  
[info@rosler.com](mailto:info@rosler.com)

#### USA

**Rösler Metal Finishing USA, L.L.C.**  
1551 Denso Road  
USA-Battle Creek  
MI 49037  
Tel.: +1 269 / 4413000  
Fax: +1 269 / 4413001  
[rosler-us@rosler.com](mailto:rosler-us@rosler.com)

#### France

**Rösler France**  
Z.I. de la Fontaine d'Azon  
CS 50513 - St. Clément  
F-89105 Sens Cedex  
Tel.: +33 3 / 86647979  
Fax: +33 3 / 86655194  
[rosler-fr@rosler.com](mailto:rosler-fr@rosler.com)

#### Italy

**Rösler Italiana S.r.l.**  
Via Elio Vittorini 10/12  
I-20863 Concorezzo (MB)  
Tel.: +39 039 / 611521  
Fax: +39 039 / 6115232  
[rosler-it@rosler.com](mailto:rosler-it@rosler.com)

#### Switzerland

**Rösler Schweiz AG**  
Staffelbachstraße 189  
Postfach 81  
CH-5054 Kirchleerau  
Tel.: +41 62 / 7385500  
Fax: +41 62 / 7385580  
[rosler-ch@rosler.com](mailto:rosler-ch@rosler.com)

#### Spain

**Rösler International GmbH & Co. KG**  
Sucursal en España  
Polg. Ind. Cova Solera C/Roma, 7  
E-08191 Rubí (Barcelona)  
Tel.: +34 93 / 5885585  
Fax: +34 93 / 5883209  
[rosler-es@rosler.com](mailto:rosler-es@rosler.com)

#### Netherlands

**Rösler Benelux B.V.**  
Reggestraat 18  
NL-5347 JG Oss  
Postbus 829  
NL-5340 AV Oss  
Tel.: +31 412 / 646600  
Fax: +31 412 / 646046  
[rosler-nl@rosler.com](mailto:rosler-nl@rosler.com)

#### Belgium

**Rösler Benelux B.V.**  
Avenue de Ramelot 6  
Zoning Industriel  
B-1480 Tubize (Saintes)  
Tel.: +32 2 / 3610200  
Fax: +32 2 / 3612831  
[rosler-be@rosler.com](mailto:rosler-be@rosler.com)

#### Austria

**Rösler Oberflächentechnik GmbH**  
Hetmanekgasse 15  
A-1230 Wien  
Tel.: +43 1 / 6985180-0  
Fax: +43 1 / 6985182  
[rosler-at@rosler.com](mailto:rosler-at@rosler.com)

#### Romania

**Rösler Romania SRL**  
Str. Avram Iancu 39-43  
RO-075100 Otopeni/ILFOV  
Tel.: +40 21 / 352 4416  
Fax: +40 21 / 352 4935  
[rosler-ro@rosler.com](mailto:rosler-ro@rosler.com)

#### Russia

**Rösler Russland**  
Borovaya Str. 7, bldg. 4, office 107  
111020 Moscow  
Tel. / Fax: +7 495 / 247 55 80  
[rosler-ru@rosler.com](mailto:rosler-ru@rosler.com)

#### Great Britain

**Rösler UK Ltd.**  
Unity Grove, School Lane  
Knowsley Business Park  
GB-Prescot, Merseyside L34 9GT  
Tel.: +44 151 / 4820444  
Fax: +44 151 / 4824400  
[rosler-uk@rosler.com](mailto:rosler-uk@rosler.com)

#### Brazil

**Rösler Otec do Brasil LTDA**  
Av. Antonio Angelo Amadio, 1421  
Centro Empresarial Castelo Branco  
18550-000 Boituva  
São Paulo - Brasil  
Tel.: +55 15 / 3264-1117  
Tel.: +55 15 / 3264-1112  
[info@rosler-otec.com.br](mailto:info@rosler-otec.com.br)

#### China

**Rösler SURFACE-TECH (BEIJING) CO., LTD.**  
Beijing Office  
Fu Hua Mansion, Office A-11-K  
No. 8, Chao Yang Men North Avenue  
Beijing 100027, P.R. China  
Tel.: +86 10 / 6554 73 86  
Fax: +86 10 / 6554 73 87  
[rosler-cn@rosler.com](mailto:rosler-cn@rosler.com)

and over 150 additional distributors  
around the world



Find your contact