

**DLyte**<sup>®</sup>  
PRO500



Precise metal  
surface finishing  
for mass  
production

Powered by **DryLyte**<sup>®</sup> TECHNOLOGY

**DLytePRO500**<sup>®</sup> is the most advanced, powerful and versatile metal surface finishing equipment on the market specially designed for mass production. The new **DLytePRO500**<sup>®</sup> provides high quality metal surface finishing better, faster, and more efficiently. The new equipment using *DryLyte Technology* delivers fully automated high quality surface finishing for high value, delicate or complex work pieces with precise and targeted finishing requirements. By combining the power of electrochemistry with a precise mechanical movement, it removes the roughness from the workpieces. It brings significant technical advantages over competing technologies such as abrasive finishing, robotic grinding and polishing, mechanical brush and grinding systems. The *DryLyte Technology* allows the user to obtain a quality equivalent to manual grinding and polishing fast and cost-effectively.

***Faster · Easier · Cost-Efficient · Precise***

***DLytePRO500***<sup>®</sup>

the revolution in Metal Surface Finishing

by

**GPA INNOVA**



# The most advanced, powerful and versatile metal surface finishing machine on the market

DLyte PRO500 offers significant technical advantages over current metal surface finishing technologies on the market. The unique dry electropolishing technology used obtains a quality equivalent to manual polishing quickly and affordably. DLyte PRO500 is designed for finishing large batches or heavy workpieces requiring high quality finishing.

The DLyte PRO500 system can be easily integrated into any manufacturing line, requiring highly complex grinding and polishing processes. The system combines an intelligent, proven, and robust design with a high output in a very small footprint.



## How it works



### TECHNOLOGY INTRODUCTION



Powered by DryLyte Technology DLyte PRO500 works by combining the electrical flow created by the **high precision** rectifier with the movement of the pieces through the electropolishing media. This results in an ion exchange, removing material only from the peaks of roughness. The process does not round edges and can access internal corners that are not easily accessed mechanically.

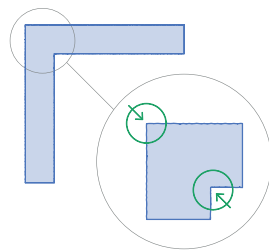
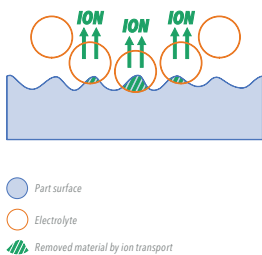

The process removes material only from the peaks of the roughness.

The process does not round edges and can penetrate the internal cavities of the piece.

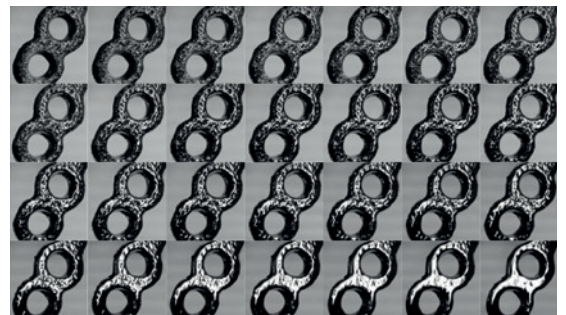

Macro sequence of a DryLyte Technology Polishing Process.

# Benefits of the technology



**1**  
Achieves **homogeneous** results across the surface and eliminates micro-scratches. The system works efficiently at micro and macroscopic level.



**2**  
**Geometry preservation.** Respects the tolerances and preserves the initial shape, even the cutting edges. It is not rounding the edges as there is no abrasion of the surface.

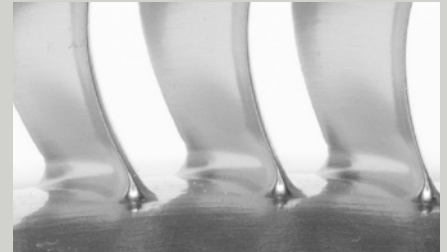

**3**  
**Best in class surface roughness** (Ra under 0,01 micrometers).



**4**  
**Repeatability and homogeneity** guaranteed. DLyte process guarantees stable results among different batches within the electrolyte media lifespan. There is no wear as would typically occur with abrasive particles.



**5**  
Up to **10x faster** than current processes, replaces multiple process steps and **competitive cost** per part.



**6**  
**Biocompatibility** proven. **Clean, non-hazardous** and easy waste management. Alternative abrasive processes lead to extremely dusty and noisy environment.



**7**  
Enhances negative surface skewness (rsk) which increases the surface bearing contact area (allowing uniform lubricant film distribution) **improving the bearing ratio and reducing the friction** between the pieces.

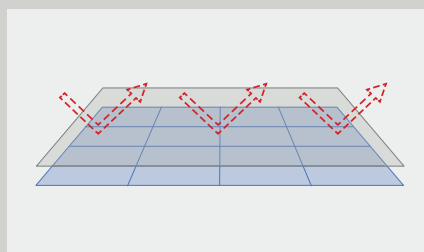

**8**  
Avoids generating grinding texture patterns, **improving wear and fracture resistance, and improving fatigue resistance.** Isotropic surfaces.

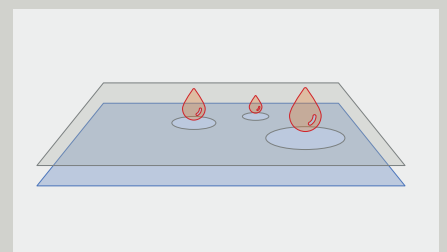

**9**  
DLyte is the only system able to remove roughness and **improve the corrosion resistance** of the metal pieces at the same time reducing the number of processes required in the manufacturing process.

# Best-in-Class repeatability, performance and capacity with the latest technology

Repeatability and high output is achieved with **innovative power electronics**, utilizing the new SIC Pulser technology, with 8 independent high frequency rectifiers synchronized by optical fiber, delivering up to 360 Amps and 35 KW. The new reliable electronics provide better surface finishes, more homogeneous results and shorter cycle times.

This is achieved by optimizing the parameters, applying asymmetric pulses and creating multiple movements. The system is capable of a wide range of parameters and process combinations.

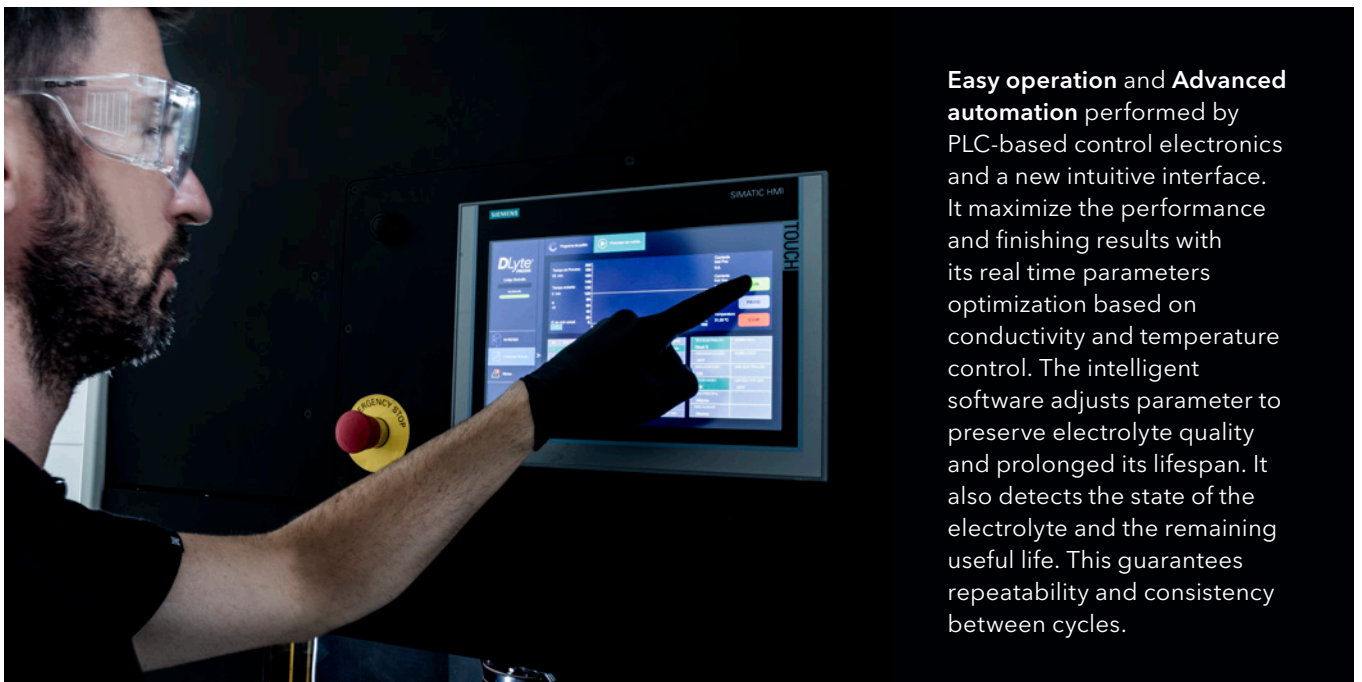

**Easy operation** and **Advanced automation** performed by PLC-based control electronics and a new intuitive interface. It maximizes the performance and finishing results with its real time parameters optimization based on conductivity and temperature control. The intelligent software adjusts parameter to preserve electrolyte quality and prolonged its lifespan. It also detects the state of the electrolyte and the remaining useful life. This guarantees repeatability and consistency between cycles.

The new DLyte PRO500 is designed with **robust** and **reliable mechanics** to work continuously in mass production. It is a **high capacity, versatile system** which includes 3 mechanical movements on the 8 spindles, and vibration on the perimeter spindles and work bowl. Combined freely, they allow the electrolyte media to flow efficiently through the pieces increasing process performance.



# Quick coupling for easy plug and release of the holders

The new holder fixation system with **positive pressure fixation** and **automatic locking system** with pneumatic connection, reduces the loading and unloading times and ease of use. The vibration system of the holders is integrated into the machine, allowing a stronger vibration supply to the piece, and a substantial decrease on the weight of the holders.

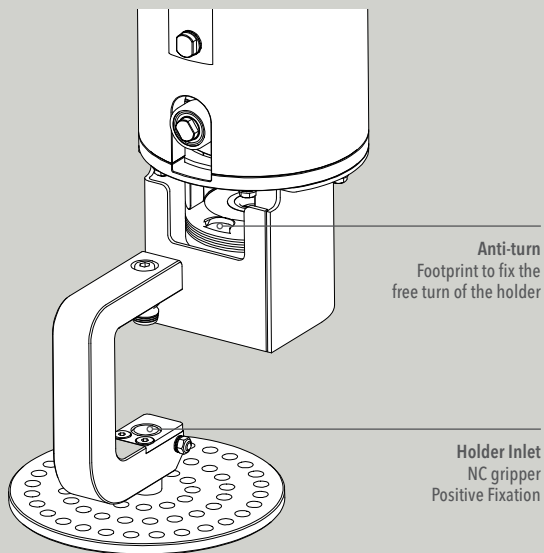

## Automatic extraction and cleaning system

At the beginning of the process, the pieces are immersed in the electrolyte media in the work bowl. At the end of the cycle, they are removed automatically, and cleaned by an airblade which also removes the electrolyte media particles from the pieces. This recovers the media electrolyte, and avoids side effects of the electrolyte on the work pieces such as pitting, oxidation, or marks.

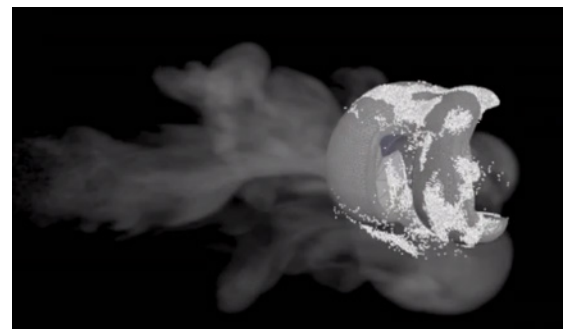

# Multiple movement combinations with a robust design

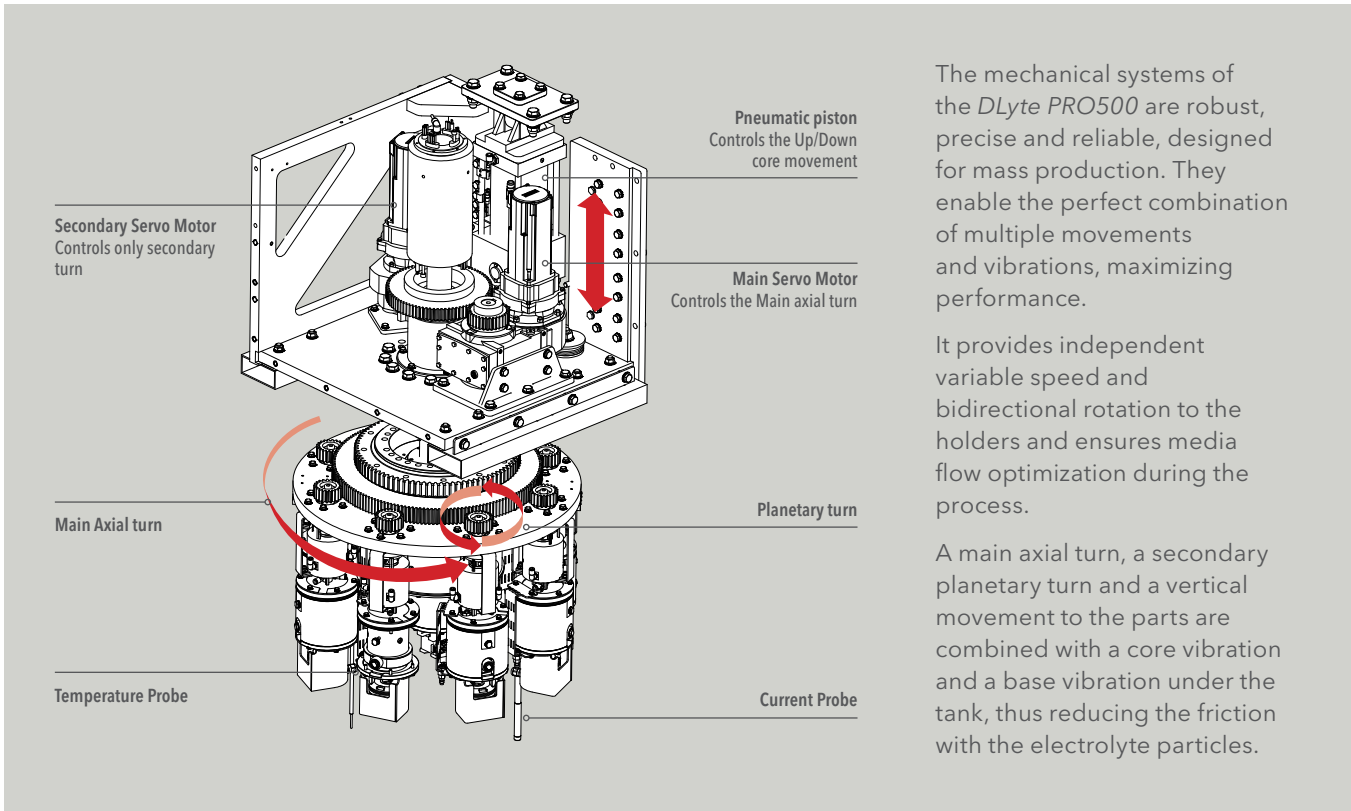

The mechanical systems of the *DLyte PRO500* are robust, precise and reliable, designed for mass production. They enable the perfect combination of multiple movements and vibrations, maximizing performance.

It provides independent variable speed and bidirectional rotation to the holders and ensures media flow optimization during the process.

A main axial turn, a secondary planetary turn and a vertical movement to the parts are combined with a core vibration and a base vibration under the tank, thus reducing the friction with the electrolyte particles.

## CORE VIBRATION

All holder heads have pneumatic vibration system, ensuring an additional movement to the parts.

## BASE VIBRATION

The work bowl has vibration motor ensuring that the electrolyte is always in permanent motion.

## MAIN AXIS MOVEMENT

It drags the parts around the whole tank, ensuring all parts sides receive an homogeneous influence from the cathodes.

## PLANETARY MOVEMENT

It drags the parts in a planetary movement concentric to their secondary axis, ensuring all part sides receive an homogeneous influence from the cathodes.

## VERTICAL MOVEMENT

Generated by the pneumatic system in the core, it has a stroke length of 20 mm.

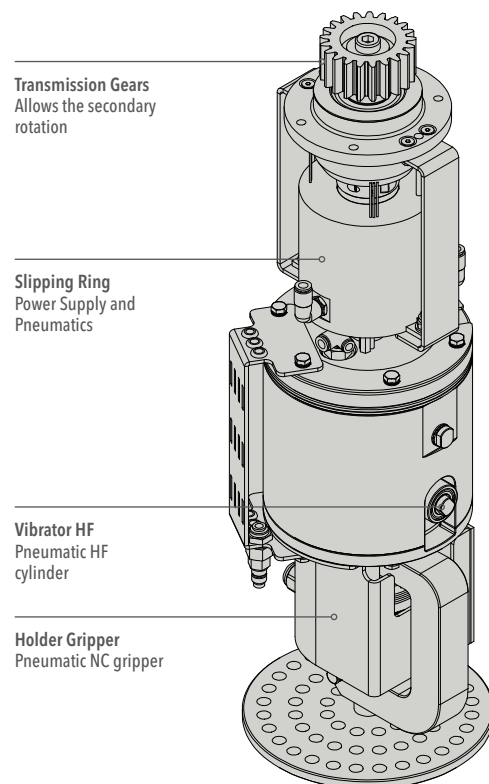



# Single and multiple work piece holders



The work piece holders or fixtures containing the work pieces are specially designed to optimize the results based on the piece geometry and finishing requirements. The large versatility of the holding systems ensure capacity optimization for several applications and versatility to use one machine for a wide range of pieces.

## Working volumes

DLyte PRO500 is equipped with 8 perimeter spindles allowing polishing of one or multiple pieces each, using different holders, for a maximum volume of 200 x 200 mm per spindle. The cathode is very close, allowing optimization of capacity as well as improving material removal during the process.

Additionally, the system includes a centered spindle for larger parts with a maximum volume of 500 x 250mm. This, combined with the bottom work bowl cathode, ensures homogenous finishing across the piece.

The relationship of the surface of the work piece and the volume of the electrolyte is reduced, improving the electrical current flow and reducing the temperature and the possibility of pitting on the parts surface.

Ø 500 mm x 250 mm

Ø 200 mm x 200 mm (x8)

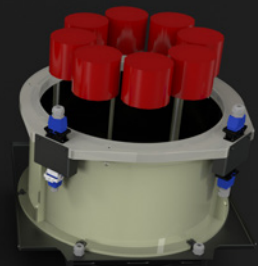
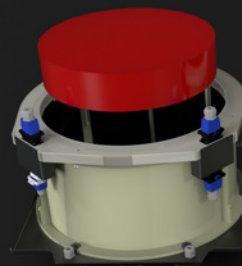

Up to Maximum 500 Ø x 250 mm volume part

Up to Maximum 8 holders of 200 mm Ø x 200 mm volume

Ø 500 mm (x1)

Ø 180 mm (x8)

Ø 100 mm (x24)

Ø 15 mm (x88)

25 mm x 25 mm (x384)

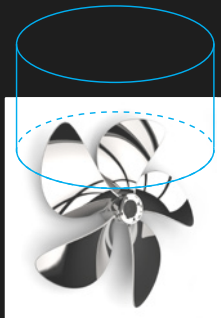

1 Propeller of 500 mm Ø

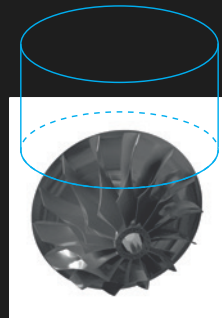

8 impellers of 180 mm Ø



24 knee implants per cycle

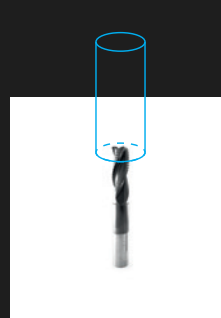

88 drill bits per cycle

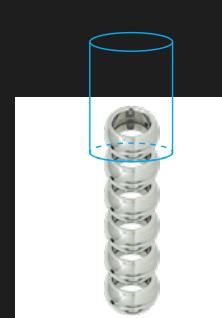

384 bearings per cycle

# Adaptative independent cathodes

The system includes the possibility to activate the perimeter and inferior cathodes independently, based on the requirements of the polishing. This function allows to achieve finishes of greater precision by adapting the electrical current flow to be optimized, based on the geometry of the piece, achieving a more homogeneous finish. In terms of the geometry/shape of the piece, achieving a more homogeneous finishing. This function provides to the system greater versatility compared to the alternative solutions in the market.



3 different machine packages available depending on the finishing needs.

# Wide range of materials

DLyte PRO500 delivers the full range of electrical parameters, from low to high frequency, parameter concatenation and asymmetric voltage.

In addition, it allows the user to search the ideal parameters for its pieces in the library of processes in the Polishing Manager APP.

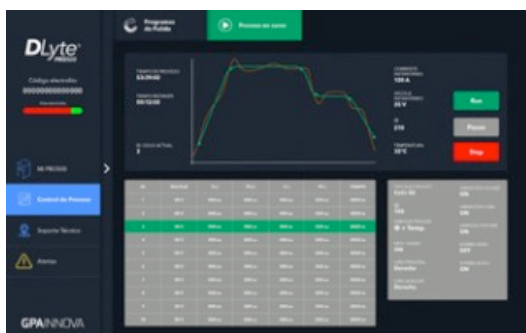

- **Cobalt Chrome**
- **Stainless Steel**
- **Carbon Steel**
- **Carbides**
- **Nickel Alloys**
- **Aluminium Alloys**
- **Copper Alloys**
- **Titanium Alloys**

# Compact footprint and multiple process replacement

DLyte PRO500 replaces several post-process steps and save space in the factory as it does not require additional peripherals as water recycling or waste management as other technologies do.

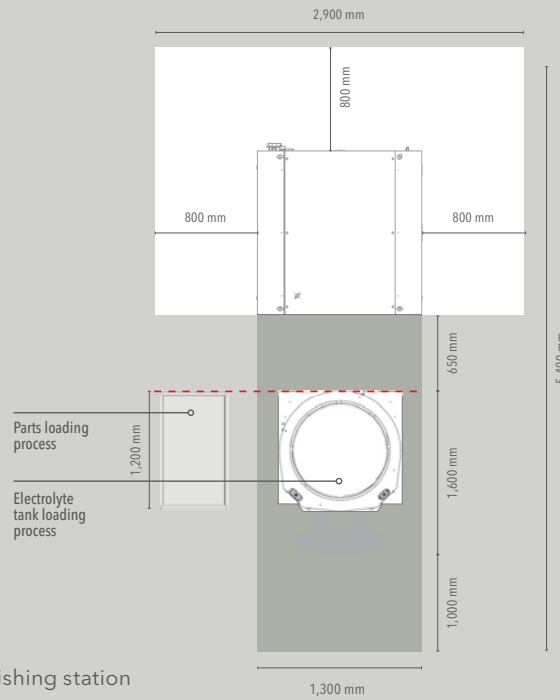

## Workspace Reduction

60%

Ceramic polishing station  
DLyte PRO500

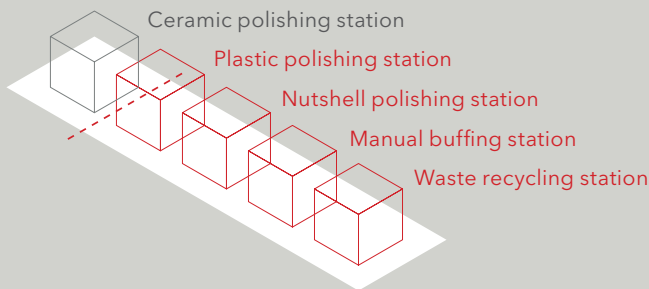

50%

## Process steps Reduction

The process is able to reduce several steps of surface finishing eliminating over 50% of the processes and 60% of the workspace required.

Furthermore, DLyte process is very safe as it is not generating dust or gas and it does not involve manipulation of hazardous liquid chemicals.

# High Performance with outstanding quality

DLyte PRO500 improves the quality and reduces the polishing time up to 80% compared to other surface finishing methods and technologies. The technology is capable of achieving roughness below 0,01 microns in one simple process.

The holders can be customized in various fixations, allowing for the polishing of one large piece or up to hundreds of smaller pieces strategically attached in 8 peripheral holders. This allows for great versatility in a variety of sectors.

24 knee implants per cycle

24

Total process time reduction

80%

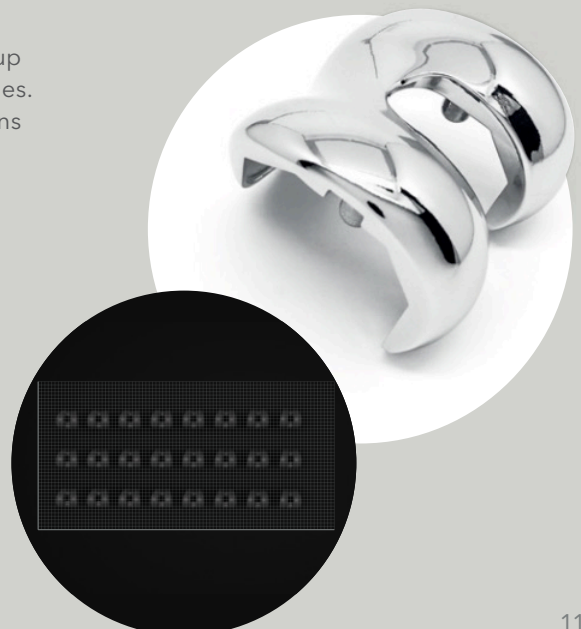

# Full Connected, Digital

*DLyte PRO500* is a totally connected machine. It comes with Ethernet and USB ports, and it connects to the new client's portal in the cloud "HUB DLyte". This digitalization of the production allows you to monitor the process, receive system status updates, track a maintenance schedule, and update polishing programs monitoring, status of the system, maintenance schedule or download and update polishing programs, electrolyte status, and the traceability of the processes required for the most demanding industry.





# HUB

The new customer portal that unifies all the services you need for a high quality finishing



Industry 4.0 IOT connectivity

- Process Consulting
- Maintenance platform
- Polishing management
- E-commerce
- Electrolyte Management
- Knowledge Platform

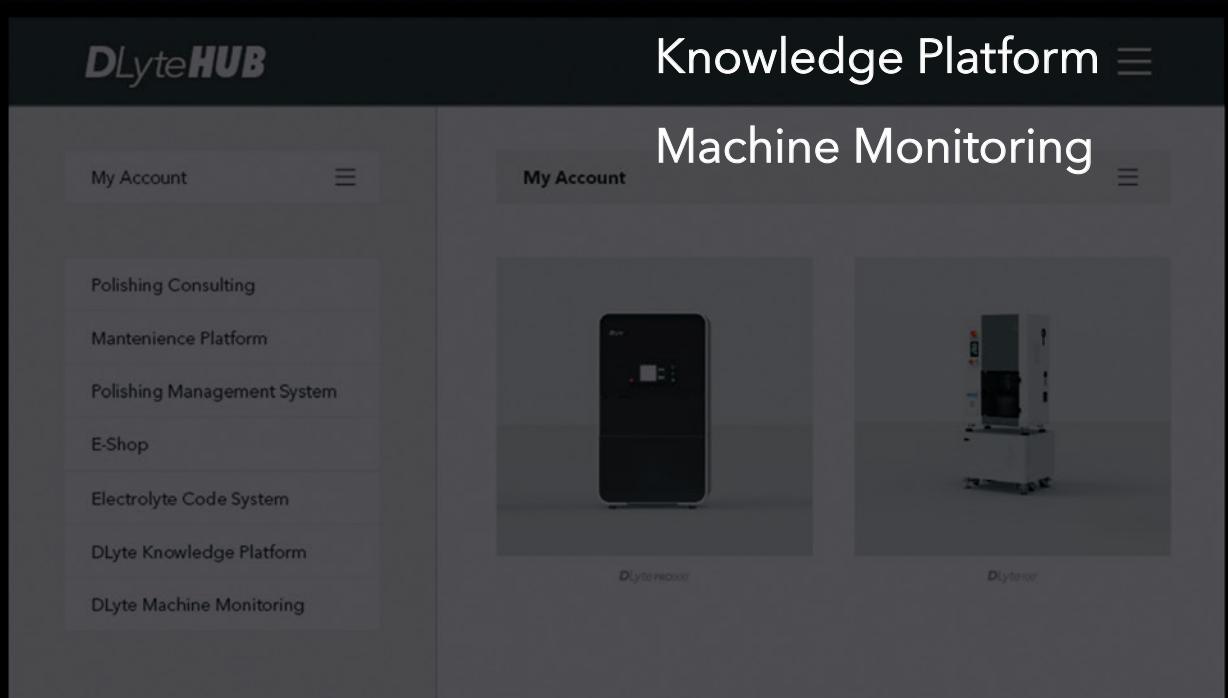

# Clean and safe environment

Exhaust system delivering up to 380 m<sup>3</sup> /h with the most reliable molecular filter for high efficiency and long-term control of molecular contaminants in sensitive process industries.

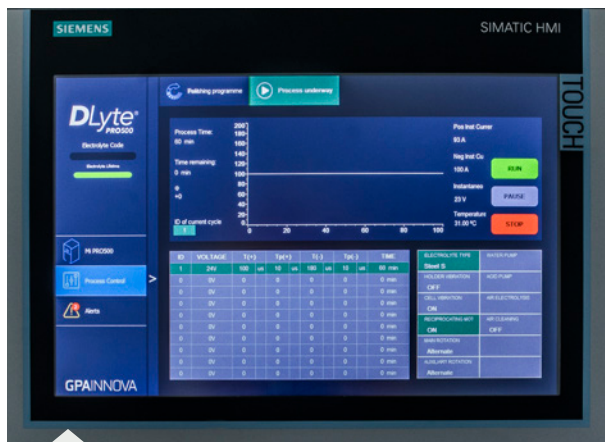
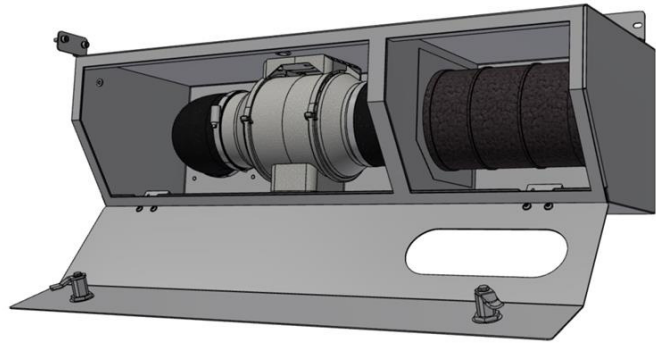

# Easy maintenance access

The design of the frame and its panels facilitates the access to the internal components for easy maintenance and operation. The eight power units are located on the sides of the machine with forced cooling and separated from the control unit located on the rear side.

# User-friendly interface with Advanced HMI

12 inch Panel with TFT color widescreen display. High performance, functionality and numerous integrated interfaces offer the greatest convenience in DLyte application.



# Sophisticated and reliable safety mechanisms

## WARNING LIGHT TOWER READY

Keep an eye on your production processes at all times with the compact and reliable warning light tower.



## MAGNETIC SAFETY GATE SYSTEM

With an electromagnetic holding force of 500 N or 1000 N, the safety gate systems prevent the safeguard from being opened unintentionally. Thanks to manipulation-proof actuators they offer maximum safety.

## SAFETY LIGHT BARRIER FOR FINGER, HAND AND BODY PROTECTION

The safety light barriers enable an ergonomic work environment. This is the case when operator intervention is required as part of each cycle, such as insertion work, or the loading and unloading of work pieces.



# Clean and safe handling and storage of electrolyte media

Easy, quick and safe electrolyte media loading and unloading in the work bowl with the Electrolyte vacuum system provided as accessory for *DLyte PRO500*.



Electrolyte vacuum system offered as accessory.

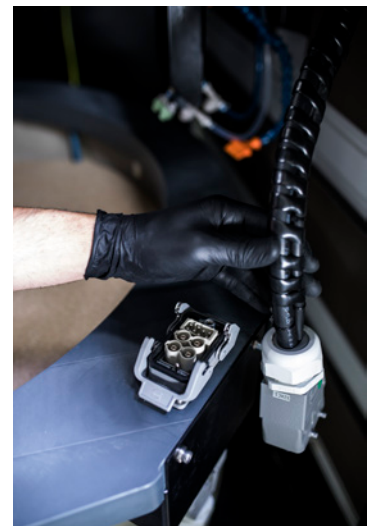

# Easy media loading and unloading

The work bowl containing the electrolyte media can be easily loaded and unloaded in the machine with a manual pallet truck or forklift avoiding any hazards for operators. The work bowl includes quick electrical connections to reduce the time of operation.



# Innovative electrolyte media

A perfect surface requires the right combination of DLyte Machine, DLyte Electrolyte Media and finishing process parameters. We have a wide range of DLyte Electrolyte Media to ensure your workpieces look exactly how you want after processing.

This helps us achieve the perfect processing result for you, regardless of what you require. Our expert guidance and technical advice are essential for an optimal process.

The new software connected to the HUB, enables automatic identification of the electrolyte by scanning a QR code with the app. This facilitates the verification of the electrolyte, ensuring a total traceability of the process.

DLyte PRO500 has independent conductivity and temperature probes which, when immersed in the electrolyte, offer readings to the automatic electrolyte conditioning system to optimize performance and life.





**DLYTE PRO500 TECHNICAL SPECIFICATIONS**

**MAIN DATA**

Capacity (per cycle)	≤ Ø 500 x 250 mm (x1) ≤ Ø 200 x 200 mm (x8)
Dimensions	1,300 x 1,300 x 2,480 mm
Electrolyte capacity	250 L
Weight	2,000 kg
Power consumption	35 kW
Power Supply	380 - 400 Vac - Thriphasic (3P+N+GND)
Frequency	50 - 60 Hz
Main Air Supply Pressure	6 - 7 bar (Air connector Ø 10 mm)
Main Air Supply Pressure (Min. Air Flow)	1,000 L/min
Holder Air Supply Pressure	6 - 7 bar (Air connector Ø 12 mm)
Holder Air Supply Pressure (Min. Air Flow)	1,500 L/min
Water Tank Capacity	16 L
Water Tank Connector	Connection (Ø 10 mm)
Acid tank	6,5 L
Exhaust Gas Pipe	Ø 125 mm
Exhaust Gas (Max. Temperature)	60 °C

**TECHNICAL DRAWING**

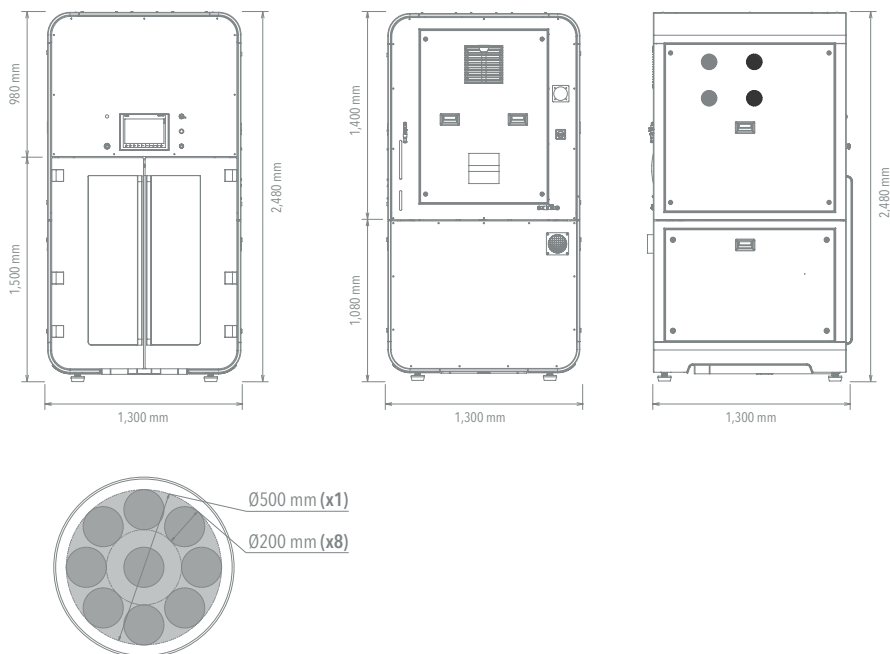

For further details, see Dlyte PRO500's Data Sheet.

**FEATURES**

**MOVEMENTS**

- Main axial turning
- Secondary planetary turning
- Vertical (up/down) ±20mm stroke
- Holder vibration
- Tank vibration
- Media aeration

**SOFTWARE**

- Programmable cycle time
- Full electropolishing parameters control
- Electrolyte life cycle control
- Temperature monitoring
- Storage capacity for 90 polishing programs
- Different cycles per program (HF and LF)
- Variable motors speed and movement
- IoT Ready: Process and Machine monitoring
- Process data can be loaded/unloaded onto external USB storage drive or Ethernet connection

**HARDWARE**

- Power Unit: Low and High frequency (Hz to MHz)
- Electropolishing Power: Up to 360 A
- 8 Automatic Holders for parts up to Ø 200 mm
- 1 Manual Holder for big parts up to Ø 500 mm
- Loading and unloading of the media by pallet truck
- Automatic cleaning of the parts with air blade
- Access traps for maintenance
- No dust emission
- Exhaust system with carbon filter
- Warning light tower ready (optional)
- No liquid waste handling
- CE Certificate



Brochure Pro500\_EN\_RevG\_0522

**DLyte PRO500**<sup>®</sup>

**GPAINNOVA**  
gpainnova.com in 